



SUNTHINKS

Hot line:400-869-3566



SHENZHEN SUNTHINKS TECHNOLOGY COMPANY LTD

Add: jiaquan A Bldg.,Guanlan High-Tech Park,Huanguan S,Road,Baoan District,Shenzhen,China.
Tel: +86-755-28058606
Fax: +86-755-28057186
E-mail: ssx@sunthinks.com
Http://www.sunthinks.com
Code:518110

深圳市深思想科技有限公司

地址: 深圳市龙华新区环观南路观澜高新科技园嘉泉大厦A栋
电话: +86-0755-28057186
传真: +86-0755-28058875
E-mail: ssx@sunthinks.com
Http://www.sunthinks.com
邮编:518110

SHENZHEN SUNTHINKS TECHNOLOGY COMPANY.,LTD
深圳市深思想科技有限公司

公司简介

COMPANY INTRODUCTION



深圳市深思想科技有限公司是一家专业生产工业数码设备的高科技企业，公司拥有自主知识产权，专业研发、生产与销售平板打印机、UV打印机等。公司致力于为工业制造企业提供专业UV数码印刷设备，并根据各个行业不同需求提供整套的应用解决方案，凭借强大的自主研发能力，开发出多款新型实用的数码印刷设备，已为广告、数码外壳、皮革彩印、建材、工艺品、玻璃、瓷砖等多个行业提供了成熟的应用解决方案，并不断创新科技，努力为更多行业提供更实用更优质更高效的应用解决方案
公司业务范围涵盖：数码印刷设备、配件服务、维修保养服务、咨询服务、创业投资规划、培训服务、方案执行等行业服务项目。

深圳市深思想科技有限公司坚持以为人本，拥有全国数码打印行业优秀的专业技术人才，研发团队拥有多年行业开发经验，成功打造多种系列数码印刷产品，在全国市场处于领先地位，积累了良好的客户口碑和品牌形象。同时深思想也在不断走向全球，为全球100多个国家和地区提供良好的产品和行业解决方案，成为行业进军全球的领头羊。

Shenzhen Sunthinks Technology Co.,Ltd is a professional high-tech enterprise which specialized in manufacturing Industrial Digital Equipment. With our independent intellectual property rights, we integrate development, production and marketing in the filed of UV digital printing equipment. We persue innovation, which devote to offer the whole high quality and efficiency printing solutions to meet different requests of various industries.

Our company persists in connecting people which have created different series digital printing products based on our excellent researching team and professional technicians in this field so that have enjoyed great reputation all around the world!

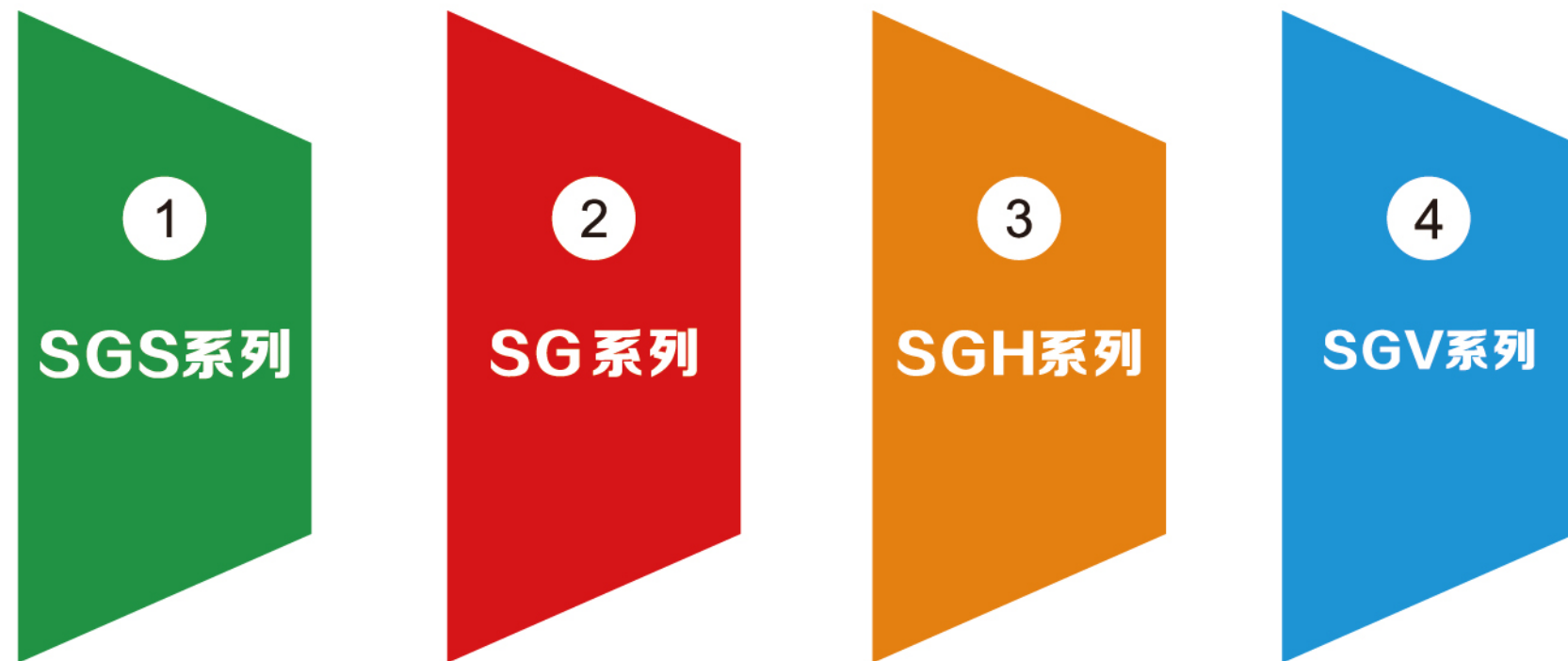

不仅是打印机
NOT ONLY PRINTER

发展历程 大事件

DEVELOPMENT HISORY 2003-2015

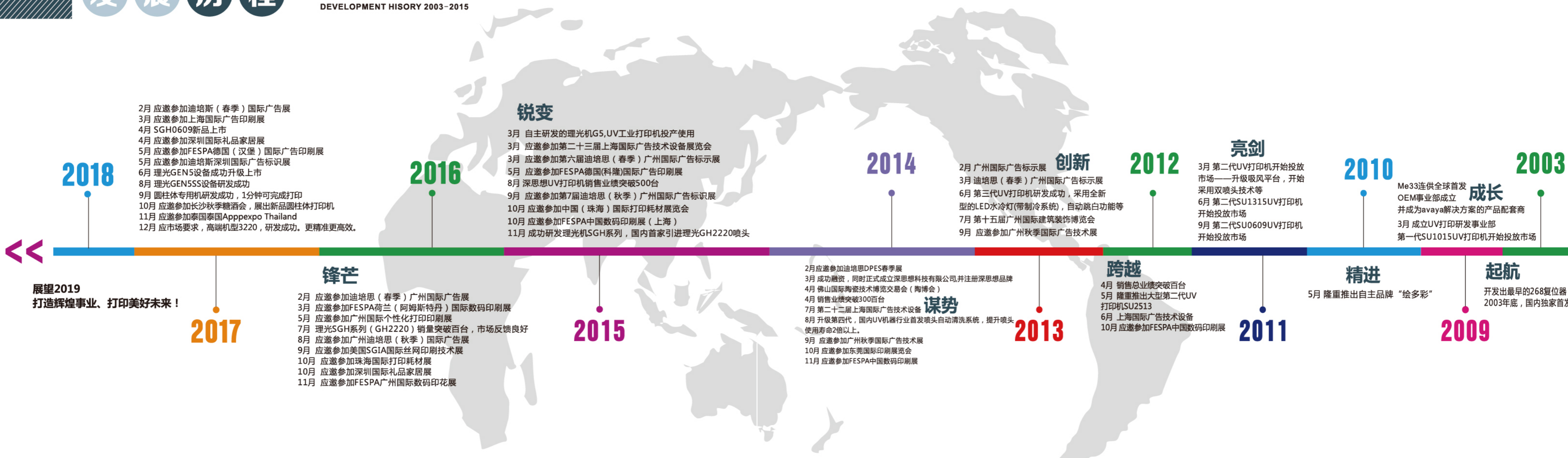

2018

- 2月 应邀参加迪培斯(春季)国际广告展
- 3月 应邀参加上海国际广告印刷展
- 4月 SGH0609新品上市
- 4月 应邀参加深圳国际礼品家居展
- 5月 应邀参加FESPA德国(汉堡)国际广告印刷展
- 5月 应邀参加迪培斯深圳国际广告标识展
- 6月 理光GEN5设备成功升级上市
- 8月 理光GEN5SS设备研发成功
- 9月 圆柱体专用机研发成功,1分钟可完成打印
- 10月 应邀参加长沙秋季糖酒会,展出新品圆柱体打印机
- 11月 应邀参加泰国泰国Appexpo Thailand
- 12月 应市场要求,高端机型3220,研发成功。更精准更高效。

锐变

- 3月 自主研发的理光机G5,UV工业打印机投产使用
- 3月 应邀参加第二十三届上海国际广告技术设备展览会
- 3月 应邀参加第六届迪培思(春季)广州国际广告标识展
- 5月 应邀参加FESPA德国(科隆)国际广告印刷展
- 8月 深思想UV打印机销售业绩突破500台
- 9月 应邀参加第7届迪培思(秋季)广州国际广告标识展
- 10月 应邀参加中国(珠海)国际打印耗材展览会
- 10月 应邀参加FESPA中国数码印刷展(上海)
- 11月 成功研发理光机SGH系列,国内首家引进理光GH2220喷头

2014

创新

- 2月 广州国际广告标识展
- 3月 迪培思(春季)广州国际广告标识展
- 6月 第三代UV打印机研发成功,采用全新型的LED水冷灯(带制冷系统),自动跳白功能等
- 7月 第十五届广州国际建筑装饰博览会
- 9月 应邀参加广州秋季国际广告技术展

2012

亮剑

- 3月 第二代UV打印机开始投放市场——升级吸风平台,开始采用双喷头技术等
- 6月 第二代SU1315UV打印机开始投放市场
- 9月 第二代SU0609UV打印机开始投放市场

2010

成长

- Me33连供全球首发
- OEM事业部成立并成为avaya解决方案的产品配套商
- 3月 成立UV打印研发事业部
- 第一代SU1015UV打印机开始投放市场

2003

起帆

- 开发出最早的268复位器
- 2003年底,国内独家首发CISS

精进

- 5月 隆重推出自主品牌“绘多彩”

2011

跨越

- 4月 销售总业绩突破百台
- 5月 隆重推出大型第二代UV打印机SU2513
- 6月 上海国际广告技术设备
- 10月 应邀参加FESPA中国数码印刷展

2013

谋势

- 2月应邀参加迪培思DPES春季展
- 3月 成功融资,同时正式成立深思想科技有限公司,并注册深思想品牌
- 4月 佛山国际陶瓷技术博览会(陶博会)
- 4月 销售业绩突破300百台
- 7月 第二十二届上海国际广告技术设备
- 8月 升级第四代,国内UV机器行业首发喷头自动清洗系统,提升喷头使用寿命2倍以上。
- 9月 应邀参加广州秋季国际广告技术展
- 10月 应邀参加东莞国际印刷展览会
- 11月 应邀参加FESPA中国数码印刷展

2015

锋芒

- 2月 应邀参加迪培思(春季)广州国际广告展
- 3月 应邀参加FESPA荷兰(阿姆斯特丹)国际数码印刷展
- 5月 应邀参加广州国际个性化打印印刷展
- 7月 理光SGH系列(GH2220)销量突破百台,市场反馈良好
- 8月 应邀参加广州迪培思(秋季)国际广告展
- 9月 应邀参加美国SGIA国际丝网印刷技术展
- 10月 应邀参加珠海国际打印耗材展
- 10月 应邀参加深圳国际礼品家居展
- 11月 应邀参加FESPA广州国际数码印花展

2017

展望2019
打造辉煌事业、打印美好未来!

客户案例

CUSTOMER CASE



Let's create brilliance hand in hand!

让我们携手共创辉煌!

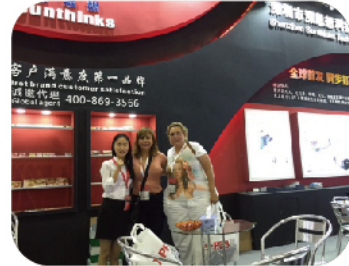

经营理念

ENTERPRISE CULTURE

Corporate vision
 企业愿景:

Make the world more beautiful
 让世界更美!

Business Philosophy
 经营理念:

Manufacture dependably, cooperate honestly!
 老老实实做生意, 踏踏实实做产品!

Service Philosophy
 服务理念:

Service upmost; Customer First.
 服务至上, 客户至上;

Corporate has its value and significance only once it services for social and customer.
 企业要为社会和客户服务, 才能体现企业的价值和意义。

Management Philosophy
 管理理念:

People-oriented; Working-hard.
 以人为本, 团结奋进;

Since a team is made up of person, only using everybody in ways where they have their strengths, the team could develop better.
 团队是由人组成的, 只有发挥每个人的优势, 才能更好的发展。

Corporate is part of social, so we should understand sharing and giving, and try our best to give back to society with grateful hearts.
 企业是社会的一部分, 应该常怀感恩之心, 尽己之力回馈社会, 懂得分享与奉献。

公司荣誉

PRODUCT HIGHLIGHTS



SGS Series (系列)

(RICOH) GEN5S 喷头

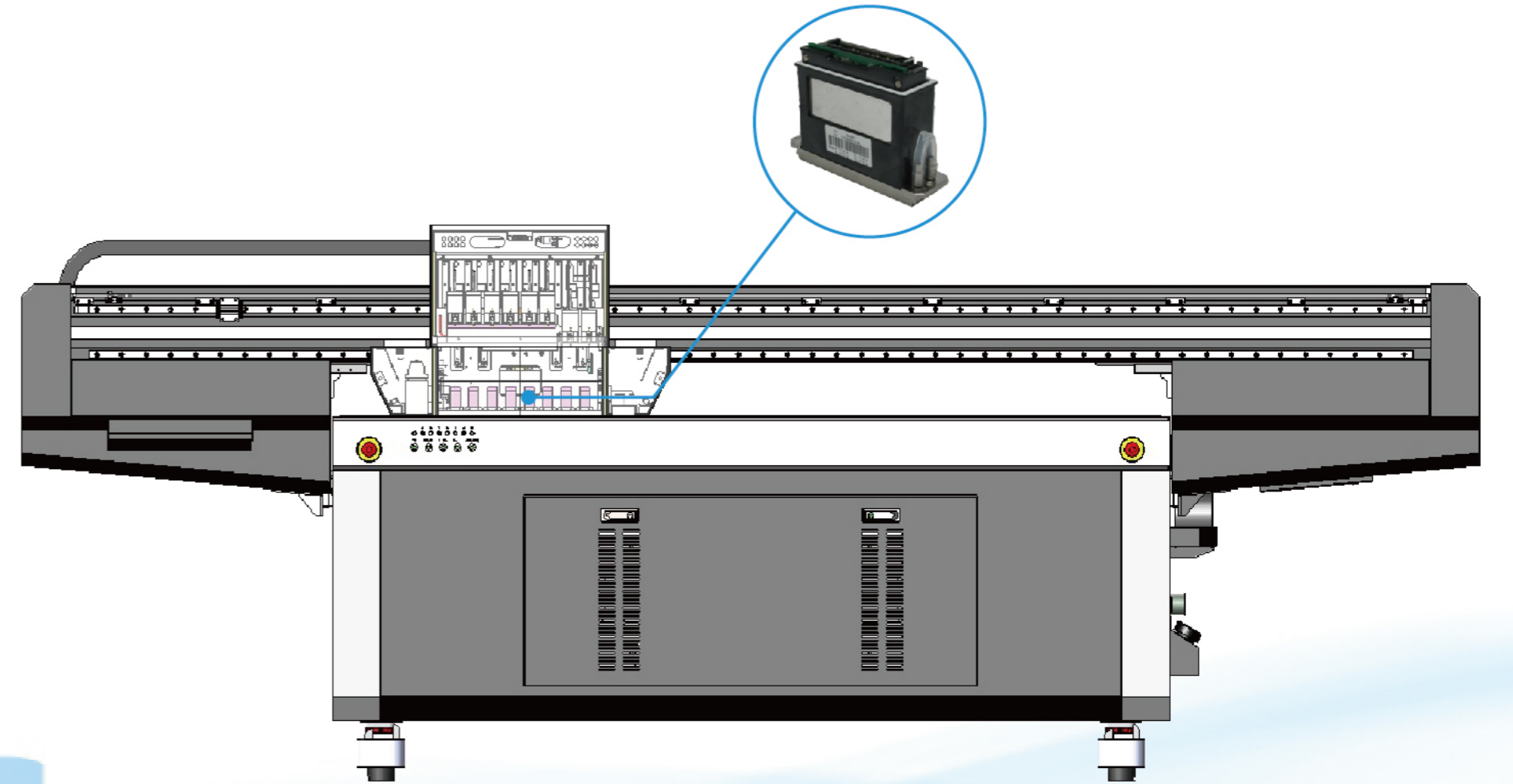

UV flatbed printer with high precision

UV平板打印机 SGS3220-V05



Product highlights 应用方案

Advertising industry,decoration industry,industrial shell, leather industry,Arts and crafts industry,Furniture home industry,toy industry,Jewelry industry,souvenir industry

广告行业、装饰行业、工业外壳、皮革行业
 工艺品行业、家具家居行业、玩具行业、
 饰品行业、纪念品等行业。



Device Features 设备特色



1. All Steel-Frame Structure 全钢一体化机架
 Applied all steel frame structure,better-structured frame made it highly stable and high-precision.
 采用全钢一体化机架，结构合理，不易变形，稳定性强



2. Linear motor drive, without any intermediate conversion mechanism
 采用直线电机，不需要任何中间转换机构的传动装置
 Dynamic response performance and positioning accuracy are greatly improved compared to servo motors
 动态响应性能和定位精度比伺服电机大大提高



3. Anti-collision system for print Head 喷头的防撞系统
 Equipped with unqueant-collision system for print head easier to adjust by different media,avoid chance to damage print head bt any misoPeration
 独有的喷头防撞系统，轻松对任何材质调试，杜绝人工失误引起的事故，更好的保护喷头



4. The X-axis is lengthened, the printing speed is significantly improved X轴加长，打印速度显著提升
 The X-axis is lengthened, the printing speed is significantly improved.
 X轴加长，打印速度显著提升

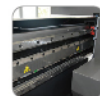

5. The magnetic scale reading X-axis data, the anti-interference ability is significantly improved, the printing precision is higher, and the life is longer.
 磁栅尺读取X轴数据，抗干扰能力显著提高，打印精度更高，寿命更长

Model type/设备型号	SGS3220-V05
Printing size / 最大输出尺寸	3200mm*2000mm
Print head type/喷头类型	GEN5+GEN5S/理光工业喷头
Print color/打印色彩	C/M/Y/K/W/V
Media thickness/最大介质厚度	150mm
Sustain Weight / 承受重量	无损精度,200KG
Printing resolution/打印精度	360dpi*300dpi,720dpi*300dpi,720dpi*600dpi,720dpi*900dpi 720dpi*1200dpi,720dpi*1800dpi
Lifting function/升降功能	Intelligent ink tank lifting, electronic-automatic/manual operation intelligent induction to inspect and adjust height 智能墨水升降,电子自动/手动智能感应检测调节高度

File format / 图像格式	TIFF(RGB & CMYK),BMP,PDF,EPS,JPEG
Ink system / 墨水系统	1000ml*8 colors/1000毫升*8色
No. of print heads/喷头数量	3-8
Printing speed / 打印速度	Draft mode:UP to 63 m/h 草稿模式:高达63平米/小时 Standard mode:UP to 50 m/h 标准模式:高达50平米/小时 Quality mode:UP to 34 m/h 高精模式:高达34平米/小时 High quality mode:UP to 24 m/h 超高模式:高达24平米/小时
Power consumption / 电力要求	50Hz/60Hz, 110/220VAC(±10%), 1.5KW
Interface/接口	High speed USB transmission interface / 高速USB传输接口
Operation system/ 作业系统	Win7/Win8/Win10
Operation condition / 工作环境	Temperatue 15°C-35°C, Reative humidity 20%-80% / 温度15°C-35°C,相对湿度20%-80%
Dimensions/外观尺寸	2850mm*4750mm*1500mm
Packing Dimensions / 包装尺寸	3050mm*4800mm*1500mm

UV flatbed printer with high precision

UV平板打印机 SGS2513-V05



Product highlights 应用方案

Advertising industry,decoration industry,industrial shell, leather industry,Arts and crafts industry,Furniture home industry,toy industry,Jewelry industry,souvenir industry

广告行业、装饰行业、工业外壳、皮革行业
 工艺品行业、家具家居行业、玩具行业、
 饰品行业、纪念品等行业。



Device Features 设备特色



1. All Steel-Frame Structure 全钢一体化机架
 Applied all steel frame structure,better-structured frame made it highly stable and high-precision.
 采用全钢一体化机架，结构合理，不易变形，稳定性强



2. Linear motor drive, without any intermediate conversion mechanism
 采用直线电机，不需要任何中间转换机构的传动装置
 Dynamic response performance and positioning accuracy are greatly improved compared to servo motors
 动态响应性能和定位精度比伺服电机大大提高



3. Anti-collision system for print Head 喷头的防撞系统
 Equipped with unqueant-collision system for print head easier to adjust by different media,avoid chance to damage print head bt any misoPeration
 独有的喷头防撞系统，轻松对任何材质调试，杜绝人工失误引起的事故，更好的保护喷头



4. The X-axis is lengthened, the printing speed is significantly improved X轴加长，打印速度显著提升
 The X-axis is lengthened, the printing speed is significantly improved.
 X轴加长，打印速度显著提升



5. The magnetic scale reading X-axis data, the anti-interference ability is significantly improved, the printing precision is higher, and the life is longer.
 磁栅尺读取X轴数据，抗干扰能力显著提高，打印精度更高，寿命更长

Model type/设备型号	SGS2513-V05
Printing size / 最大输出尺寸	2500mm*1300mm
Print head type/喷头类型	GEN5+GEN5S/理光工业喷头
Print color/打印色彩	C/M/Y/K/W/V
Media thickness / 最大介质厚度	150mm
Sustain Weight / 承受重量	无损精度,200KG
Printing resolution / 打印精度	360dpi*300dpi,720dpi*300dpi,720dpi*600dpi,720dpi*900dpi 720dpi*1200dpi,720dpi*1800dpi
Lifting function / 升降功能	Intelligent ink tank lifting, electronic-automatic/manual operation intelligent induction to inspect and adjust height 智能墨水升降,电子自动/手动智能感应检测调节高度

File format / 图像格式	TIFF(RGB & CMYK),BMP,PDF,EPS,JPEG
Ink system / 墨水系统	1000ml*8 colors/1000毫升*8色
No. of print heads / 喷头数量	3-8
Printing speed / 打印速度	Draft mode:Up to 45m/h 草稿模式:高达45平米/小时 Standard mode:Up to 36m/h 标准模式:高达36平米/小时 Quality mode:Up to 24m/h 高精模式:高达24平米/小时 High quality mode:Up to 17m/h 超高精度:高达17平米/小时
Power consumption / 电力要求	50Hz/60Hz, 110/220VAC(±10%), 1.5KW
Interface / 接口	High speed USB transmission interface / 高速USB传输接口
Operation system / 作业系统	Win7/Win8/Win10
Operation condition / 工作环境	Temperatue 15°C~35°C, Reative humidity 20%~80% / 温度15°C~35°C,相对湿度20%~80%
Dimensions / 外观尺寸	3980mm*2150mm*1450mm
Packing Dimensions / 包装尺寸	4180mm*2200mm*1500mm

UV flatbed printer with high precision

UV平板打印机 SGS1513-V05



Product highlights 应用方案

Advertising industry,decoration industry,industrial shell, leather industry,Arts and crafts industry,Furniture home industry,toy industry,Jewelry industry,souvenir industry

广告行业、装饰行业、工业外壳、皮革行业
 工艺品行业、家具家居行业、玩具行业、
 饰品行业、纪念品等行业。

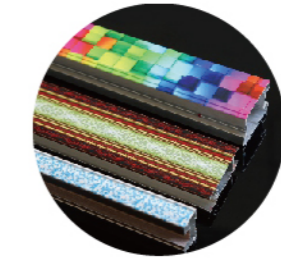

Device Features 设备特色



1. All Steel-Frame Structure 全钢一体化机架
 Applied all steel frame structure,better-structured frame made it highly stable and high-precision.
 采用全钢一体化机架，结构合理，不易变形，稳定性强



2. Linear motor drive, without any intermediate conversion mechanism
 采用直线电机，不需要任何中间转换机构的传动装置
 Dynamic response performance and positioning accuracy are greatly improved compared to servo motors
 动态响应性能和定位精度比伺服电机大大提高



3. Anti-collision system for print Head 喷头的防撞系统
 Equipped with unqueant-collision system for print head easier to adjust by different media,avoid chance to damage print head bt any misoPeration
 独有的喷头防撞系统，轻松对任何材质调试，杜绝人工失误引起的事故，更好的保护喷头



4. The X-axis is lengthened, the printing speed is significantly improved X轴加长，打印速度显著提升
 The X-axis is lengthened, the printing speed is significantly improved.
 X轴加长，打印速度显著提升



5. The magnetic scale reading X-axis data, the anti-interference ability is significantly improved, the printing precision is higher, and the life is longer.
 磁栅尺读取X轴数据，抗干扰能力显著提高，打印精度更高，寿命更长

Model type/设备型号	SGS1513-V05
Printing size / 最大输出尺寸	1500mm*1300mm
Print head type/喷头类型	GEN5+GEN5S/理光工业喷头
Print color/打印色彩	C/M/Y/K/W/V
Media thickness/最大介质厚度	150mm
Sustain Weight / 承受重量	无损精度,200KG
Printing resolution/打印精度	360dpi*300dpi,720dpi*300dpi,720dpi*600dpi,720dpi*900dpi 720dpi*1200dpi,720dpi*1800dpi
Lifting function/升降功能	Intelligent ink tank lifting, electronic-automatic/manual operation intelligent induction to inspect and adjust height 智能墨水升降,电子自动/手动智能感应检测调节高度

File format / 图像格式	TIFF(RGB & CMYK),BMP,PDF,EPS,JPEG
Ink system / 墨水系统	1000ml*8 colors/1000毫升*8色
No. of print heads / 喷头数量	3-8
Printing speed / 打印速度	Draft mode:Up to 39m/h 草稿模式:高达39平米/小时 Standard mode:Up to 30m/h 标准模式:高达30平米/小时 Quality mode:Up to 18m/h 高精模式:高达18平米/小时 High quality mode:Up to 11m/h 超高精度:高达11平米/小时
Power consumption / 电力要求	50Hz/60Hz, 110/220VAC(±10%), 1.5KW
Interface / 接口	High speed USB transmission interface / 高速USB传输接口
Operation system / 作业系统	Win7/Win8/Win10
Operation condition / 工作环境	Temperatue 15°C~35°C, Reative humidity 20%~80% / 温度15°C~35°C,相对湿度20%~80%
Dimensions / 外观尺寸	2980mm*2150mm*1400mm
Packing Dimensions / 包装尺寸	3210mm*2250mm*1500mm

SG Series(系列)

(RICOH) GEN5喷头

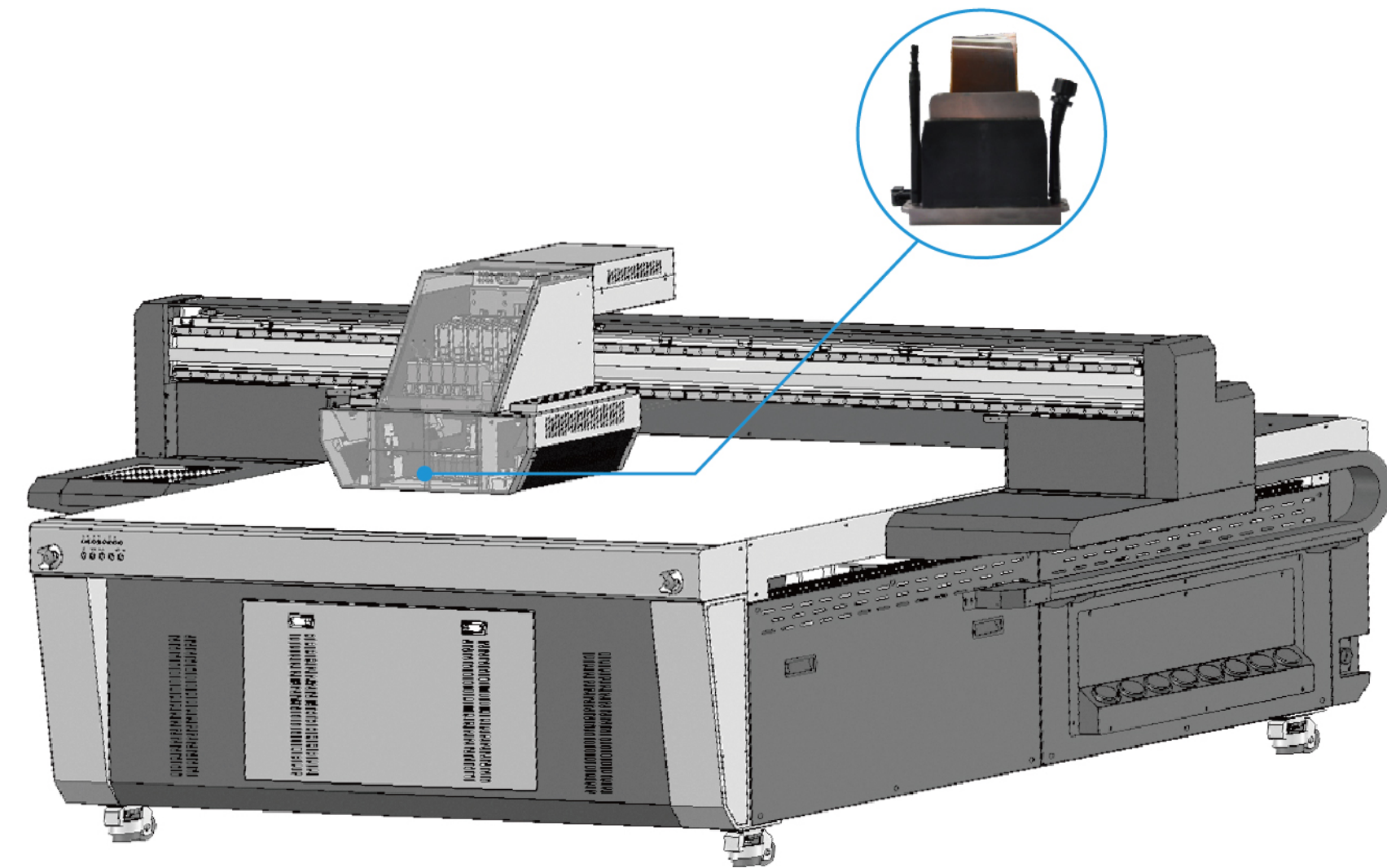

UV flatbed printer with high precision

UV平板打印机 SG3220-V05



Product highlights 应用方案

Advertising industry,decoration industry,industrial shell, leather industry,Arts and crafts industry,Furniture home industry,toy industry,Jewelry industry,souvenir industry

广告行业、装饰行业、工业外壳、皮革行业
 工艺品行业、家具家居行业、玩具行业、
 饰品行业、纪念品等行业。



Device Features 设备特色



1. All Steel-Frame Structure 全钢一体化机架
 Applied all steel frame structure,better-structured frame made it highly stable and high-precision.
 采用全钢一体化机架，结构合理，不易变形，稳定性强



2. Linear motor drive, without any intermediate conversion mechanism
 采用直线电机，不需要任何中间转换机构的传动装置
 Dynamic response performance and positioning accuracy are greatly improved compared to servo motors
 动态响应性能和定位精度比伺服电机大大提高



3. Anti-collision system for print Head 喷头的防撞系统
 Equipped with unqueant-collision system for print head easier to adjust by different media,avoid chance to damage print head bt any misoPeration
 独有的喷头防撞系统，轻松对任何材质调试，杜绝人工失误引起的事故，更好的保护喷头



4. The X-axis is lengthened, the printing speed is significantly improved X轴加长，打印速度显著提升
 The X-axis is lengthened, the printing speed is significantly improved.
 X轴加长，打印速度显著提升



5. The magnetic scale reading X-axis data, the anti-interference ability is significantly improved, the printing precision is higher, and the life is longer.
 磁栅尺读取X轴数据，抗干扰能力显著提高，打印精度更高，寿命更长

Model type/设备型号	SG3220-V05
Printing size /最大输出尺寸	3200mm*2000mm
Print head type/喷头类型	GEN5/理光工业喷头
Print color/打印色彩	C/M/Y/K/W/LC/LM/V
Media thickness/最大介质厚度	150mm
Sustain Weight /承受重量	无损精度,200KG
Printing resolution/打印精度	360dpi*300dpi,720dpi*300dpi,720dpi*600dpi,720dpi*900dpi 720dpi*1200dpi,720dpi*1800dpi
Lifting function/升降功能	Intelligent ink tank lifting, electronic-automatic/manual operation intelligent induction to inspect and adjust height 智能墨水升降,电子自动/手动智能感应检测调节高度

File format /图像格式	TIFF(RGB & CMYK),BMP,PDF,EPS,JPEG
Ink system /墨水系统	1000ml*8 colors/1000毫升*8色
No. of print heads/喷头数量	3-8
Printing speed / 打印速度	Draft mode:UP to 63 m/h 草稿模式:高达63平米/小时 Standard mode:UP to 50 m/h 标准模式:高达50平米/小时 Quality mode:UP to 34 m/h 高精模式:高达34平米/小时 High quality mode:UP to 24 m/h 超高模式:高达24平米/小时
Power consumption / 电力要求	50Hz/60Hz, 110/220VAC(±10%), 1.5KW
Interface/接口	High speed USB transmission interface / 高速USB传输接口
Operation system/ 作业系统	Win7/Win8/Win10
Operation condition / 工作环境	Temperatue 15°C~35°C, Reative humidity 20%~80% / 温度15°C~35°C,相对湿度20%~80%
Dimensions/外观尺寸	2850mm*4750mm*1500mm
Packing Dimensions /包装尺寸	3050mm*4800mm*1550mm

UV flatbed printer with high precision

UV平板打印机 SG2513-V05



Product highlights 应用方案

Advertising industry, decoration industry, industrial shell, leather industry, Arts and crafts industry, Furniture home industry, toy industry, Jewelry industry, souvenir industry

广告行业、装饰行业、工业外壳、皮革行业
 工艺品行业、家具家居行业、玩具行业、
 饰品行业、纪念品等行业。



Device Features 设备特色



1. All Steel-Frame Structure 全钢一体化机架
 Applied all steel frame structure, better-structured frame made it highly stable and high-precision.
 采用全钢一体化机架，结构合理，不易变形，稳定性强



2. Linear motor drive, without any intermediate conversion mechanism
 采用直线电机，不需要任何中间转换机构的传动装置
 Dynamic response performance and positioning accuracy are greatly improved compared to servo motors
 动态响应性能和定位精度比伺服电机大大提高



3. Anti-collision system for print Head 喷头的防撞系统
 Equipped with unqueant-collision system for print head easier to adjust by different media, avoid chance to damage print head bt any misoPeration
 独有的喷头防撞系统，轻松对任何材质调试，杜绝人工失误引起的事，更好的保护喷头



4. The X-axis is lengthened, the printing speed is significantly improved X轴加长，打印速度显著提升
 The X-axis is lengthened, the printing speed is significantly improved.
 X轴加长，打印速度显著提升

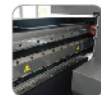

5. The magnetic scale reading X-axis data, the anti-interference ability is significantly improved, the printing precision is higher, and the life is longer.
 磁栅尺读取X轴数据，抗干扰能力显著提高，打印精度更高，寿命更长

Model type/设备型号	SG2513-V05
Printing size/最大输出尺寸	2500mm*1300mm
Print head type/喷头类型	GEN5/理光工业喷头
Print color/打印色彩	C/M/Y/K/W/LC/LM/V
Media thickness/最大介质厚度	150mm
Sustain Weight/承受重量	max. 200KG / 无损精度, 200KG
Printing resolution/打印精度	360dpi*300dpi, 720dpi*300dpi, 720dpi*600dpi, 720dpi*900dpi 720dpi*1200dpi, 720dpi*1800dpi
Lifting function/升降功能	Intelligent ink tank lifting, electronic-automatic/manual operation intelligent induction to inspect and adjust height 智能墨水升降, 电子自动/手动智能感应检测调节高度

File format/图像格式	TIFF(RGB & CMYK), BMP, PDF, EPS, JPEG
Ink system/墨水系统	1000ml*8 colors/1000毫升*8色
No. of print heads/喷头数量	3~8
Printing speed/打印速度	Draft mode: Up to 45m/h 草稿模式: 高达45平米/小时 Standard mode: Up to 36m/h 标准模式: 高达36平米/小时 Quality mode: Up to 24m/h 高精模式: 高达24平米/小时 High quality mode: Up to 17m/h 超高精度: 高达17平米/小时
Power consumption/电力要求	50Hz/60Hz, 110/220VAC(±10%), 1.5KW
Interface/接口	High speed USB transmission interface / 高速USB传输接口
Operation system/作业系统	Win7/Win8/Win10
Operation condition/工作环境	Temperatue 15°C~35°C, Reative humidity 20%~80% / 温度15°C~35°C, 相对湿度20%~80%
Dimensions/外观尺寸	3980mm*2150mm*1450mm
Packing Dimensions/包装尺寸	4180mm*2200mm*1500mm

UV flatbed printer with high precision

UV平板打印机 SG1513-V05



Product highlights 应用方案

Advertising industry,decoration industry,industrial shell, leather industry,Arts and crafts industry,Furniture home industry,toy industry,Jewelry industry,souvenir industry

广告行业、装饰行业、工业外壳、皮革行业
工艺品行业、家具家居行业、玩具行业、
饰品行业、纪念品等行业。

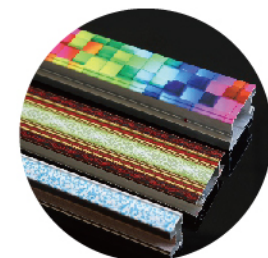

Device Features 设备特色



1. All Steel-Frame Structure 全钢一体化机架
Applied all steel frame structure,better-structured frame made it highly stable and high-precision.

采用全钢一体化机架，结构合理，不易变形，稳定性强



2. Linear motor drive, without any intermediate conversion mechanism
采用直线电机，不需要任何中间转换机构的传动装置
Dynamic response performance and positioning accuracy are greatly improved compared to servo motors
动态响应性能和定位精度比伺服电机大大提高

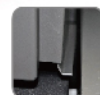

3. Anti-collision system for print Head 喷头的防撞系统
Equipped with unqueant-collision system for print head easier to adjust by different media,avoid chance to damage print head bt any misoPeration
独有的喷头防撞系统，轻松对任何材质调试，杜绝人工失误引起的事，更好的保护喷头



4. The X-axis is lengthened, the printing speed is significantly improved X轴加长，打印速度显著提升
The X-axis is lengthened, the printing speed is significantly improved.
X轴加长，打印速度显著提升

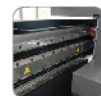

5. The magnetic scale reading X-axis data, the anti-interference ability is significantly improved, the printing precision is higher, and the life is longer.
磁栅尺读取X轴数据，抗干扰能力显著提高，打印精度更高，寿命更长

Model type/设备型号	SG1513-V05
Printing size /最大输出尺寸	1500mm*1300mm
Print head type/喷头类型	GEN5/理光工业喷头
Print color/打印色彩	C/M/Y/K/W/LC/LM/V
Media thickness/最大介质厚度	150mm
Sustain Weight /承受重量	max. 200KG / 无损精度,200KG
Printing resolution/打印精度	360dpi*300dpi,720dpi*300dpi,720dpi*600dpi,720dpi*900dpi 720dpi*1200dpi,720dpi*1800dpi
Lifting function/升降功能	Intelligent ink tank lifting, electronic-automatic/manual operation intelligent induction to inspect and adjust height 智能墨水升降,电子自动/手动智能感应检测调节高度

File format / 图像格式	TIFF(RGB & CMYK),BMP,PDF,EPS,JPEG
Ink system / 墨水系统	1000ml*8 colors/1000毫升*8色
No. of print heads / 喷头数量	3~8
Printing speed / 打印速度	Draft mode:Up to 39m/h 草稿模式:高达39平米/小时 Standard mode:Up to 30m/h 标准模式:高达30平米/小时 Quality mode:Up to 18m/h 高精模式:高达18平米/小时 High quality mode:Up to 11m/h 超高精度:高达11平米/小时
Power consumption / 电力要求	50Hz/60Hz, 110/220VAC(±10%), 1.5KW
Interface/接口	High speed USB transmission interface / 高速USB传输接口
Operation system / 作业系统	Win7/Win8/Win10
Operation condition / 工作环境	Temperatue 15°C~35°C, Reative humidity 20%~80% / 温度15°C~35°C,相对湿度20%~80%
Dimensions/外观尺寸	2980mm*2150mm*1400mm
Packing Dimensions / 包装尺寸	3210mm*2250mm*1500mm

SG Series (系列)
SGH Series (系列)
(RICOH)GH2220 喷头

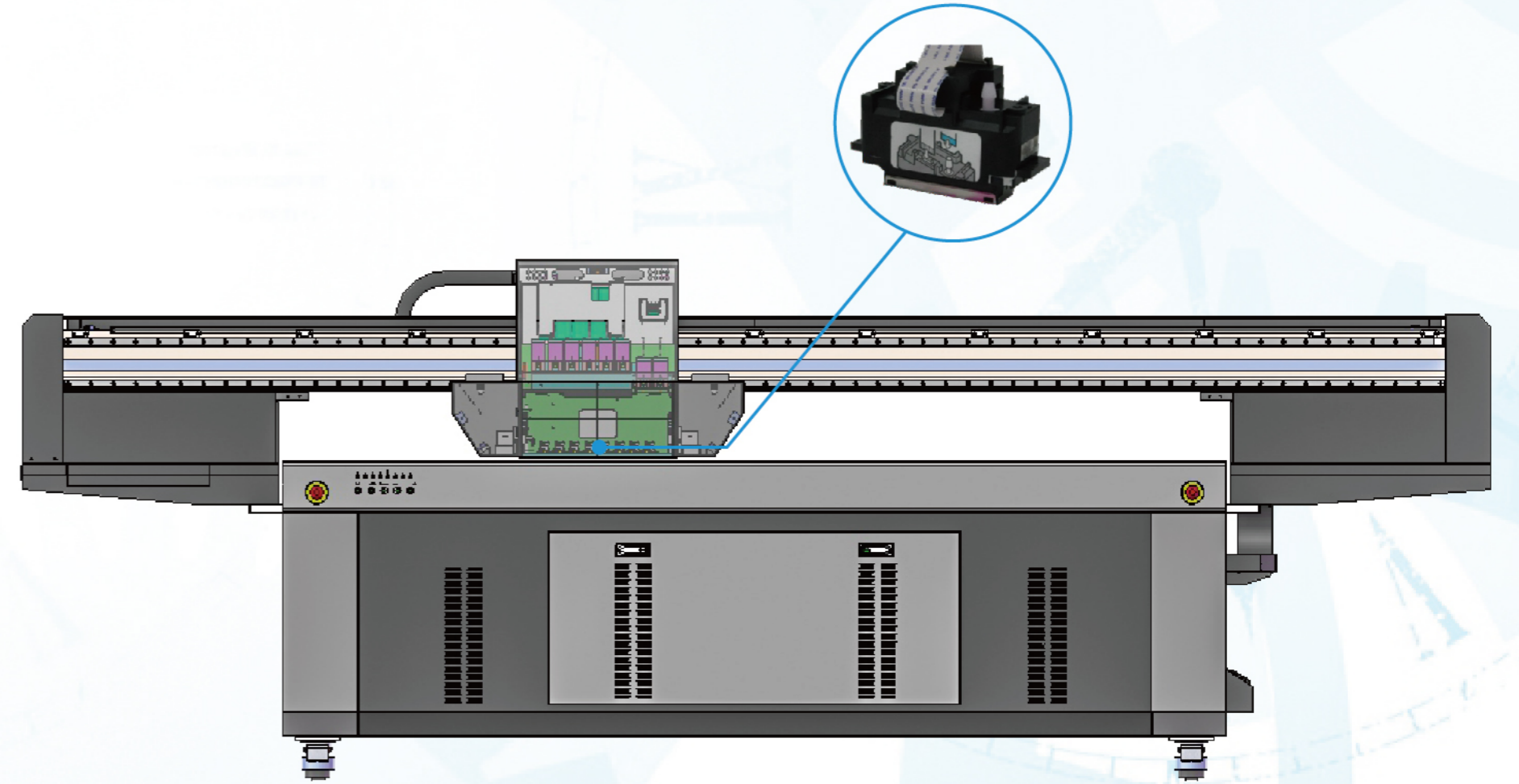

UV flatbed printer with high precision

UV平板打印机 SGH2030-V05



Product highlights 应用方案

Advertising industry, decoration industry, industrial shell, leather industry, Arts and crafts industry, Furniture home industry, toy industry, Jewelry industry, souvenir industry

广告行业、装饰行业、工业外壳、皮革行业
 工艺品行业、家具家居行业、玩具行业、
 饰品行业、纪念品等行业。



Device Features 设备特色



1. All Steel-Frame Structure 全钢一体化机架
 Applied all steel frame structure, better-structured frame made it highly stable and high-precision.
 采用全钢一体化机架，结构合理，不易变形，稳定性强

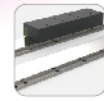

2. Linear motor drive, without any intermediate conversion mechanism
 采用直线电机，不需要任何中间转换机构的传动装置
 Dynamic response performance and positioning accuracy are greatly improved compared to servo motors
 动态响应性能和定位精度比伺服电机大大提高

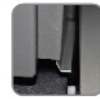

3. Anti-collision system for print Head 喷头的防撞系统
 Equipped with unqueant-collision system for print head easier to adjust by different media, avoid chance to damage print head bt any misoPeration
 独有的喷头防撞系统，轻松对任何材质调试，杜绝人工失误引起的事，更好的保护喷头



4. The X-axis is lengthened, the printing speed is significantly improved X轴加长，打印速度显著提升
 The X-axis is lengthened, the printing speed is significantly improved.
 X轴加长，打印速度显著提升

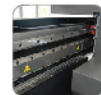

5. The magnetic scale reading X-axis data, the anti-interference ability is significantly improved, the printing precision is higher, and the life is longer.
 磁栅尺读取X轴数据，抗干扰能力显著提高，打印精度更高，寿命更长

Model type/设备型号	SGH2030-V05
Print head type/喷头类型	Gh2220 / 理光工业喷头
Quantity of the Printer head / 喷头数	6~8
Resolution / 打印精度	720*600dpi, 720*900dpi, 720*1200dpi, 720*1800dpi,
Printing speed with 6 printer head for Rich Gh2220 Gh2220 6喷头高速打印速度	4Pass 720*600dpi - 24 sqm/h
	6Pass 720*900dpi -16 sqm/h
	8Pass 720*1200dpi -10 sqm/h
Printing speed with 8 printer head for Rich Gh2220 Gh2220 8喷头高速打印速度 双彩	4pass 32m ² /h
	6pass 20m ² /h
	8pass 16m ² /h
Ink type / 墨水类型	热转印墨水, 弱溶剂墨水, 水性墨水, 热升华墨水, UV墨水 Sublimation ink, Eco-solvent ink, Water-based ink, Dye Sublimation, UV INK
Color / 颜色	K/C/M/Y/W+varnish(optional)

Material / 材料类型	Sublimation paper, Lamp-box fabric, One-way vision 热转印纸, 灯箱布, 车身贴, 单透膜等
File format / 图像文件格式	TIFF(RGB & CMYK), BMP, PDF, EPS, JPEG
Printing workflow / 打印工作流程	Printing after RIP or RIP while printing / RIP后打印或边RIP边打印
Cleansystem / 清洗系统	Automatic ink pressure system / 自动压墨系统
Print interface / 打印接口	USB
Print software / 软件	RYPIC/Ultraprint/Photoprint/Colorgate/Wasatch
Operation system / 作业系统	Win7/Win8/Win10/XP
RAM / 内存	4G或以上
Disk / 硬盘	250G或以上
Ambient humidity / 环境湿度	45-75%CH
Temperature / 温度	20-27°C

UV flatbed printer with high precision

UV平板打印机 SGH2513-V05



Product highlights 应用方案

Advertising industry, decoration industry, industrial shell, leather industry, Arts and crafts industry, Furniture home industry, toy industry, Jewelry industry, souvenir industry

广告行业、装饰行业、工业外壳、皮革行业
 工艺品行业、家具家居行业、玩具行业、
 饰品行业、纪念品等行业。



Device Features 设备特色



1. All Steel-Frame Structure 全钢一体化机架
 Applied all steel frame structure, better-structured frame made it highly stable and high-precision.
 采用全钢一体化机架，结构合理，不易变形，稳定性强



2. Linear motor drive, without any intermediate conversion mechanism
 采用直线电机，不需要任何中间转换机构的传动装置
 Dynamic response performance and positioning accuracy are greatly improved compared to servo motors
 动态响应性能和定位精度比伺服电机大大提高



3. Anti-collision system for print Head 喷头的防撞系统
 Equipped with unqueant-collision system for print head easier to adjust by different media, avoid chance to damage print head bt any misoPeration
 独有的喷头防撞系统，轻松对任何材质调试，杜绝人工失误引起的事，更好的保护喷头



4. The X-axis is lengthened, the printing speed is significantly improved X轴加长，打印速度显著提升
 The X-axis is lengthened, the printing speed is significantly improved.
 X轴加长，打印速度显著提升



5. The magnetic scale reading X-axis data, the anti-interference ability is significantly improved, the printing precision is higher, and the life is longer.
 磁栅尺读取X轴数据，抗干扰能力显著提高，打印精度更高，寿命更长

Model type/设备型号	SGH2513-V05
Print head type/喷头类型	Gh2220 / 理光工业喷头
Quantity of the Printer head / 喷头数	6~8
Resolution / 打印精度	720*600dpi, 720*900dpi, 720*1200dpi, 720*1800dpi,
Printing speed with 6 printer head for Rich Gh2220 Gh2220 6喷头高速打印速度	4Pass 720*600dpi -24 sqm/h
	6Pass 720*900dpi -16 sqm/h
	8Pass 720*1200dp -10 sqm/h
Printing speed with 8 printer head for Rich Gh2220 Gh2220 8喷头高速打印速度 双彩	4pass 32m ² /h
	6pass 20m ² /h
	8pass 16m ² /h
Ink type / 墨水类型	热转印墨水, 弱溶剂墨水, 水性墨水, 热升华墨水, UV墨水 Sublimation ink, Eco-solvent ink, Water-based ink, Dye Sublimation, UV INK
Color / 颜色	K/C/M/Y/W+varnish(optional)

Material / 材料类型	Sublimation paper, Lamp-box fabric, One-way vision 热转印纸, 灯箱布, 车身贴, 单透膜等
File format / 图像文件格式	TIFF(RGB & CMYK), BMP, PDF, EPS, JPEG
Printing workflow / 打印工作流程	Printing after RIP or RIP while printing / RIP后打印或边RIP边打印
Cleansystem / 清洗系统	Automatic ink pressure system / 自动压墨系统
Print interface / 打印接口	USB
Print software / 软件	RYPIC/Ultraprint/Photoprint/Colorgate/Wasatch
Operation system / 作业系统	Win7/Win8/Win10/XP
RAM / 内存	4G或以上
Disk / 硬盘	250G或以上
Ambient humidity / 环境湿度	45-75%CH
Temperature / 温度	20-27°C

UV flatbed printer with high precision

UV平板打印机 SGH1513-V05



Product highlights 应用方案

Advertising industry,decoration industry,industrial shell, leather industry,Arts and crafts industry,Furniture home industry,toy industry,Jewelry industry,souvenir industry

广告行业、装饰行业、工业外壳、皮革行业
 工艺品行业、家具家居行业、玩具行业、
 饰品行业、纪念品等行业。

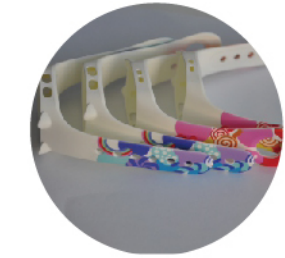

Device Features 设备特色



1. All Steel-Frame Structure 全钢一体化机架
 Applied all steel frame structure,better-structured frame made it highly stable and high-precision.
 采用全钢一体化机架，结构合理，不易变形，稳定性强

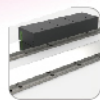

2. Linear motor drive, without any intermediate conversion mechanism
 采用直线电机，不需要任何中间转换机构的传动装置
 Dynamic response performance and positioning accuracy are greatly improved compared to servo motors
 动态响应性能和定位精度比伺服电机大大提高



3. Anti-collision system for print Head 喷头的防撞系统
 Equipped with unqueant-collision system for print head easier to adjust by different media,avoid chance to damage print head bt any misoPeration
 独有的喷头防撞系统，轻松对任何材质调试，杜绝人工失误引起的事故，更好的保护喷头



4. The X-axis is lengthened, the printing speed is significantly improved X轴加长，打印速度显著提升
 The X-axis is lengthened, the printing speed is significantly improved.
 X轴加长，打印速度显著提升

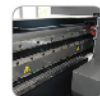

5. The magnetic scale reading X-axis data, the anti-interference ability is significantly improved, the printing precision is higher, and the life is longer.
 磁栅尺读取X轴数据，抗干扰能力显著提高，打印精度更高，寿命更长

Model type/设备型号	SGH1513-V05
Print head type/喷头类型	GH2220 / 理光工业喷头
Quantity of the Printer head / 喷头数	6~8
Resolution / 打印精度	360dpi*300dpi,720dpi*300dpi,720dpi*600dpi,720dpi*900dpi 720dpi*1200dpi,720dpi*1800dpi
Printing speed with 6 printer head for Rich Gh2220 Gh2220 喷头高速打印速度	4Pass 720*600dpi -16 sqm/h
	6Pass 720*900dpi -10 sqm/h
	8Pass 720*1200dpi -8 sqm/h
Printing speed with 8 printer head for Rich Gh2220 Gh2220 8喷头高速打印速度 双彩	4pass 32m ² /h
	6pass 20m ² /h
	8pass 16m ² /h
Ink type / 墨水类型	热转印墨水,弱溶剂墨水, 水性墨水, 热升华墨水, UV墨水 Sublimation ink, Eco-solvent ink, Water-based ink, Dye Sublimation, UV INK
Color / 颜色	K/C/M/Y/W

Material / 材料类型	Sublimation paper, Lamp-box fabric, One-way vision 热转印纸, 灯箱布, 车身贴, 单透膜等
File format / 图像文件格式	TIFF(RGB & CMYK),BMP,PDF,EPS,JPEG
Printing workflow/打印工作流程	Printing after RIP or RIP while printing / RIP后打印或边RIP边打印
Cleansystem / 清洗系统	Automatic ink pressure system /自动压墨系统
Print interface / 打印接口	USB
Print software / 软件	RYPIC/Ultaprint/Photoprint/Colorgate/Wasatch
Operation system / 作业系统	Win7/Win8/Win10/XP
RAM / 内存	4G或以上
Disk / 硬盘	250G或以上
Ambient humidity / 环境湿度	45-75%CH
Temperature/温度	20-27°C

UV flatbed printer with high precision

UV平板打印机 SGH1115-V05



Product highlights 应用方案

Advertising industry,decoration industry,industrial shell, leather industry,Arts and crafts industry,Furniture home industry,toy industry,Jewelry industry,souvenir industry

广告行业、装饰行业、工业外壳、皮革行业
 工艺品行业、家具家居行业、玩具行业、
 饰品行业、纪念品等行业。



Device Features 设备特色



1. All Steel-Frame Structure 全钢一体化机架
 Applied all steel frame structure,better-structured frame made it highly stable and high-precision.
 采用全钢一体化机架，结构合理，不易变形，稳定性强



2. Linear motor drive, without any intermediate conversion mechanism
 采用直线电机，不需要任何中间转换机构的传动装置
 Dynamic response performance and positioning accuracy are greatly improved compared to servo motors
 动态响应性能和定位精度比伺服电机大大提高



3. Anti-collision system for print Head 喷头的防撞系统
 Equipped with unqueant-collision system for print head easier to adjust by different media,avoid chance to damage print head bt any misoPeration
 独有的喷头防撞系统，轻松对任何材质调试，杜绝人工失误引起的事故，更好的保护喷头



4. The X-axis is lengthened, the printing speed is significantly improved X轴加长，打印速度显著提升
 The X-axis is lengthened, the printing speed is significantly improved.
 X轴加长，打印速度显著提升



5. The magnetic scale reading X-axis data, the anti-interference ability is significantly improved, the printing precision is higher, and the life is longer.
 磁栅尺读取X轴数据，抗干扰能力显著提高，打印精度更高，寿命更长

Model type/设备型号	SGH1115-V05
Print head type/喷头类型	Gh2220 / 理光工业喷头
Quantity of the Printer head / 喷头数	6~8
Resolution / 打印精度	360dpi*300dpi,720dpi*300dpi,720dpi*600dpi,720dpi*900dpi 720dpi*1200d ,720dpi*1800dpi
Printing speed with 6 printer head for Rich Gh2220 Gh2220 喷头高速打印速度	4Pass 720*600dpi - 14 sqm/h
	6Pass 720*900dpi - 8 sqm/h
	8Pass 720*1200dpi - 6 sqm/h
Printing speed with 8 printer head for Rich Gh2220 Gh2220 8喷头高速打印速度 双彩	4pass28m ² /h
	6pass14m ² /h
	8pass12m ² /h
Ink type / 墨水类型	热转印墨水,弱溶剂墨水，水性墨水，热升华墨水，UV墨水 Sublimation ink, Eco-solvent ink, Water-based ink, Dye Sublimation , UV INK
Color / 颜色	K/C/M/Y/W/V

Material / 材料类型	Sublimation paper, Lamp-box fabric, One-way vision 热转印纸，灯箱布，车身贴，单透膜等
File format / 图像文件格式	TIFF(RGB & CMYK),BMP,PDF,EPS,JPEG
Printing workflow/打印工作流程	Printing after RIP or RIP while printing / RIP后打印或边RIP边打印
Cleansystem / 清洗系统	Automatic ink pressure system /自动压墨系统
Print interface / 打印接口	USB
Print software / 软件	RYPIC/Ultaprint/Photoprint/Colorgate/Wasatch
Operation system/ 作业系统	Win7/Win8/Win10/XP
RAM / 内存	4G或以上
Disk/ 硬盘	250G或以上
Ambient humidity / 环境湿度	45-75%CH
Temperature/温度	20-27°C

UV flatbed printer with high precision

UV平板打印机

SGH07590-V05



Product highlights 应用方案

Advertising industry,decoration industry,industrial shell, leather industry,Arts and crafts industry,Furniture home industry,toy industry,Jewelry industry,souvenir industry

广告行业、装饰行业、工业外壳、皮革行业
 工艺品行业、家具家居行业、玩具行业、
 饰品行业、纪念品等行业。

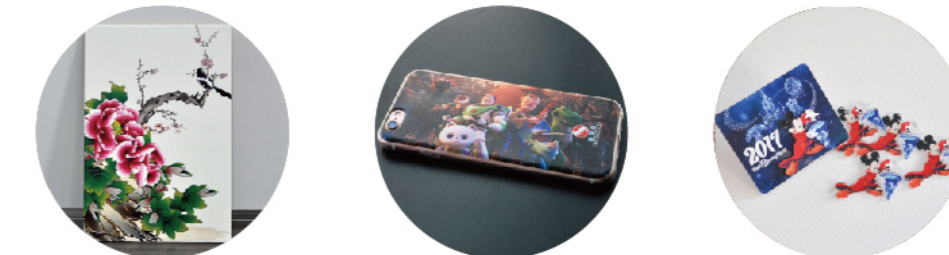

Device Features 设备特色



1. All Steel-Frame Structure 全钢一体化机架
 Applied all steel frame structure,better-structured frame made it highly stable and high-precision.
 采用全钢一体化机架，结构合理，不易变形，稳定性强



2. Linear motor drive, without any intermediate conversion mechanism
 采用直线电机，不需要任何中间转换机构的传动装置
 Dynamic response performance and positioning accuracy are greatly improved compared to servo motors
 动态响应性能和定位精度比伺服电机大大提高



3. Anti-collision system for print Head 喷头的防撞系统
 Equipped with unqueant-collision system for print head easier to adjust by different media,avoid chance to damage print head bt any misoPeration
 独有的喷头防撞系统，轻松对任何材质调试，杜绝人工失误引起的事故，更好的保护喷头



4. The X-axis is lengthened, the printing speed is significantly improved X轴加长，打印速度显著提升
 The X-axis is lengthened, the printing speed is significantly improved.
 X轴加长，打印速度显著提升



5. The magnetic scale reading X-axis data, the anti-interference ability is significantly improved, the printing precision is higher, and the life is longer.
 磁栅尺读取X轴数据，抗干扰能力显著提高，打印精度更高，寿命更长

Model type/设备型号	SGH07590-V05
Print head type/喷头类型	Gh2220 / 理光工业喷头
Quantity of the Printer head / 喷头数	3~8
Resolution / 打印精度	360dpi*300dpi,720dpi*300dpi,720dpi*600dpi,720dpi*900dpi,700dpi*1200dpi,720dpi*1600dpi 1440dpi*1200dpi,1440dpi*900dpi,1440*600dpi,1440dpi*450dpi,1440dpi*300dpi
Media thickness/最大介质厚度	100mm
Sustain Weight / 承受重量	max.50KG/无损精度 50KG
Printing speed with 6 printer head for Rich Gh2220 Gh2220 喷头高速打印速度	4Pass 720*600dpi - 14 sqm/h
	6Pass 720*900dpi - 8 sqm/h
	8Pass 720*1200dpi - 6 sqm/h
Ink type / 墨水类型	热转印墨水,弱溶剂墨水,水性墨水,热升华墨水,UV墨水 Sublimation ink, Eco-solvent ink, Water-based ink, Dye Sublimation, UV INK
Color / 颜色	K/C/M/Y/W/V

Material / 材料类型	Sublimation paper, Lamp-box fabric, One-way vision 热转印纸, 灯箱布, 车身贴, 单透膜等
File format / 图像文件格式	TIFF(RGB & CMYK),BMP,PDF,EPS,JPEG
Printing workflow/打印工作流程	Printing after RIP or RIP while printing / RIP后打印或边RIP边打印
Cleansystem / 清洗系统	Automatic ink pressure system /自动压墨系统
Print interface / 打印接口	USB
Print software / 软件	RYPIC/Ultaprint/Photoprint/Colorgate/Wasatch
Operation system/ 作业系统	Win7/Win8/Win10/XP
RAM / 内存	4G或以上
Disk/ 硬盘	250G或以上
Ambient humidity / 环境湿度	45-75%CH
Temperature/温度	20-27°C



UV flatbed printer with high precision

UV平板打印机

SGH0606-V05

Hot line:400-869-3566

Product highlights 应用方案

Advertising industry,decoration industry,industrial shell, leather industry,Arts and crafts industry,Furniture home industry,toy industry,Jewelry industry,souvenir industry

广告行业、装饰行业、工业外壳、皮革行业
工艺品行业、家具家居行业、玩具行业、
饰品行业、纪念品等行业。



Device Features 设备特色



1. All Steel-Frame Structure 全钢一体化机架
Applied all steel frame structure,better-structured frame made it highly stable and high-precision.
采用全钢一体化机架，结构合理，不易变形，稳定性强

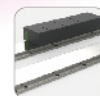

2. Linear motor drive, without any intermediate conversion mechanism
采用直线电机，不需要任何中间转换机构的传动装置
Dynamic response performance and positioning accuracy are greatly improved compared to servo motors
动态响应性能和定位精度比伺服电机大大提高



3. Anti-collision system for print Head 喷头的防撞系统
Equipped with unqueant-collision system for print head easier to adjust by different media,avoid chance to damage print head bt any misoPeration
独有的喷头防撞系统，轻松对任何材质调试，杜绝人工失误引起的事故，更好的保护喷头



4. The X-axis is lengthened, the printing speed is significantly improved X轴加长，打印速度显著提升
The X-axis is lengthened, the printing speed is significantly improved.
X轴加长，打印速度显著提升

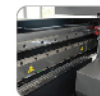

5. The magnetic scale reading X-axis data, the anti-interference ability is significantly improved, the printing precision is higher, and the life is longer.
磁栅尺读取X轴数据，抗干扰能力显著提高，打印精度更高，寿命更长

Model type/设备型号	SGH0606-V05
Print head type/喷头类型	Gh2220 / 理光工业喷头
Quantity of the Printer head / 喷头数	3~8
Resolution / 打印精度	360dpi*300dpi,720dpi*300dpi,720dpi*600dpi,720dpi*900dpi,700dpi*1200 1440dpi*1200dpi,1440dpi*900dpi,1440*600dpi,1440dpi*450dpi,1440dpi*300dpi
Media thickness/最大介质厚度	80mm
Sustain Weight / 承受重量	max.30Kg/无损精度30Kg
Printing speed with 4 printer head for Rich Gh2220 Gh2220 喷头高速打印速度	4Pass 1440*300dpi - 10 sqm/h 720*300dpi - 12 sqm/h 8Pass 1440*600dpi - 6 sqm/h 720*600dpi - 10 sqm/h
Ink type / 墨水类型	热转印墨水,弱溶剂墨水, 水性墨水, 热升华墨水, UV墨水 Sublimation ink, Eco-solvent ink, Water-based ink, Dye Sublimation, UV INK
Color / 颜色	K/C/M/Y/W/V

Material / 材料类型	Sublimation paper, Lamp-box fabric, One-way vision 热转印纸, 灯箱布, 车身贴, 单透膜等
File format / 图像文件格式	TIFF(RGB & CMYK),BMP,PDF,EPS,JPEG
Printing workflow/打印工作流程	Printing after RIP or RIP while printing / RIP后打印或边RIP边打印
Cleansystem / 清洗系统	Automatic ink pressure system /自动压墨系统
Print interface / 打印接口	USB
Print software / 软件	RYPIC/Ultraprint/Photoprint/Colorgate/Wasatch
Operation system / 作业系统	Win7/Win8/Win10/XP
RAM / 内存	4G或以上
Disk / 硬盘	250G或以上
Ambient humidity / 环境湿度	45-75%CH
Dimensions/外观尺寸	1800mm*1230mm*1500mm(机架型) 1800mm*1230mm*600mm (桌面型)

UV flatbed printer with high precision

UV 酒瓶打印机 SGH-JP-V05



Product highlights 应用方案

Wine bottle industry, wine packaging industry, water cup industry and so on. Regular cylinder or cone.

酒瓶行业，酒包装盒行业，水杯行业等有规则的圆柱体或锥形。



Device Features 设备特色



1. All Steel-Frame Structure 全钢一体化机架
 Applied all steel frame structure,better-structured frame made it highly stable and high-precision.
 采用全钢一体化机架，结构合理，不易变形，稳定性强



2. Linear motor drive, without any intermediate conversion mechanism
 采用直线电机，不需要任何中间转换机构的传动装置
 Dynamic response performance and positioning accuracy are greatly improved compared to servo motors
 动态响应性能和定位精度比伺服电机大大提高



3. Anti-collision system for print Head 喷头的防撞系统
 Equipped with unqueant-collision system for print head easier to adjust by different media,avoid chance to damage print head bt any misoPeration
 独有的喷头防撞系统，轻松对任何材质调试，杜绝人工失误引起的事故，更好的保护喷头



4. The X-axis is lengthened, the printing speed is significantly improved X轴加长，打印速度显著提升
 The X-axis is lengthened, the printing speed is significantly improved.
 X轴加长，打印速度显著提升

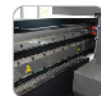

5. The magnetic scale reading X-axis data, the anti-interference ability is significantly improved, the printing precision is higher, and the life is longer.
 磁栅尺读取X轴数据，抗干扰能力显著提高，打印精度更高，寿命更长

Model type/设备型号	SGH-JP-V05
Printing size/最大输出尺寸	宽600mm，最大圆柱体直径110mm
Print head type/喷头类型	GH2220/理光工业喷头
Print color/打印色彩	C/M/Y/K/W/LC/LM
Media thickness/最大介质厚度	110mm
Sustain Weight/承受重量	无损精度,200KG
Printing resolution/打印精度	300dpi*300dpi, 300dpi*600dpi,300dpi*900dpi,300dpi*1200dpi,600dpi*600dpi, 600dpi*900dpi,600dpi*1200dpi,900dpi*1200dpi,1200dpi*1200dpi
Lifting function/升降功能	Intelligent ink tank lifting, electronic-automatic/manual operation intelligent induction to inspect and adjust height 智能墨水升降,电子自动/手动智能感应检测调节高度

File format/图像格式	TIFF(RGB & CMYK),BMP,PDF,EPS,JPEG
Ink system/墨水系统	1000ml*8 colors/1000毫升*8色
No. of print heads/喷头数量	3~6
Printing speed / 打印速度	Draft mode:Up to 39m/h 草稿模式:高达60平米/小时 Standard mode:Up to 30m/h 标准模式:高达50平米/小时 Quality mode:Up to 18m/h 高精模式:高达40平米/小时 High quality mode:Up to 11m/h 超高精度:高达30平米/小时
Power consumption / 电力要求	50Hz/60Hz, 110/220VAC(±10%), 1.5KW
Interface/接口	High speed USB transmission interface / 高速USB传输接口
Operation system/ 作业系统	Win7/Win8/Win10/XP
Operation condition / 工作环境	Temperatue 15°C~35°C, Reative humidity 20%~80% / 温度15°C~35°C,相对湿度20%~80%
Dimensions/外观尺寸	1850mm/1000mm/1500mm
Packing Dimensions /包装尺寸	2050mm/1200mm/1600mm

SGV Series(系列)

(RICOH)GEN5喷头

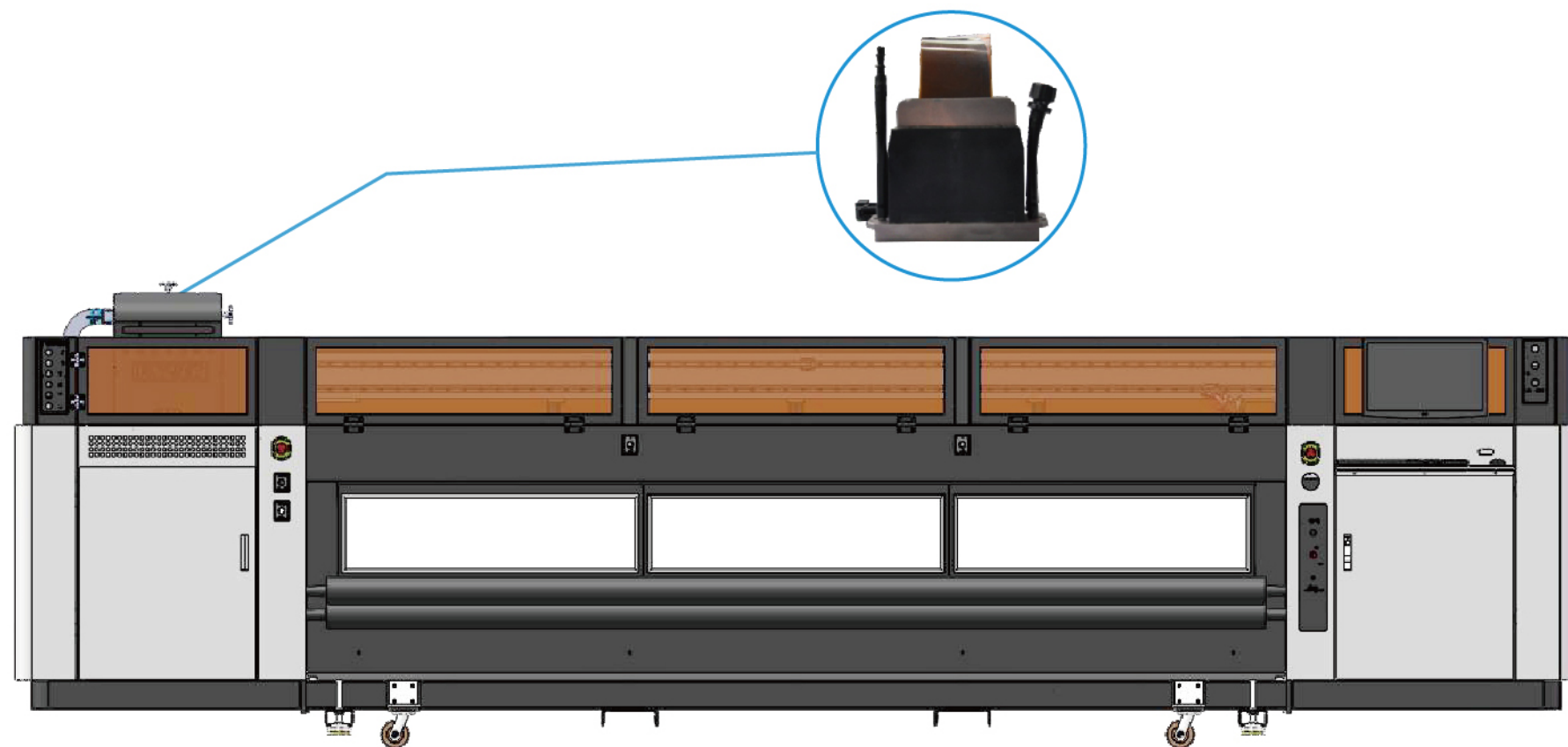

Roll to Roll UV Printer

UV 卷材打印机 SGV3200

Hot line:400-869-3566

SHENZHEN SUNTHINKS TECHNOLOGY COMPANY.,LTD
深圳市深思想科技有限公司



Product highlights 应用方案

Advertising industry,flex banner,lightbox, advertising banner,soft film,wallpaper,leather, soft membrane meshfabric ,light sheet,PP paper, sticky note , rtc.

广告行业、喷绘布、灯箱布、广告条幅、软膜、墙纸、皮革、软膜网状织物、灯片、PP纸、即时贴等。



白墨自动循环、缺墨报警系统,实现白墨主墨桶间歇性功能,保证白色墨水时刻保持流动状态,防止墨水沉淀,另外配备墨水缺墨报警系统,从而保证喷绘连续性



前后恒张力高精度收放料系统,更人性化操作,长幅画面送料准确无误。



标配LED照明面板,让打印画面效果更直观



电子配件布局简洁,方便日常维护



分色压墨,有效节约墨水;简洁直观全自动缺墨报警系统,有效保证生产流畅、不间断输出



高强度不变形打印平台:内置密封材料吸附腔体,平台精度方便可调、吸附力度附表方便可调;让材料吸附平整,充分保证完美品质输出。



日本进口双THK导轨
Japan Imported double THK guide rail



台达驱动、电机
Delta driver,motor

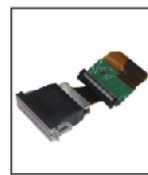

日本理光GEN5喷头
Japan Ricoh GEN5 printhead



美国PhotoPrint软件
America Photoprint Software

设备型号	SGV3200-V05
喷头技术	理光GEN5灰度级喷头
打印速度	4Pass:40平方/小时 6Pass:28平方/小时 8Pass:20平方/小时
输出精度	最高可达720*1440dpi
喷墨技术	按需即喷压电式喷墨方式,UV喷墨技术
墨水类型	采用环保专用LED-UV墨水
适用介质	喷绘布、灯箱布、广告条幅、软膜、皮革、墙纸、灯片、PP纸、软膜网状织物等
颜色配置	C、M、Y、K、Lc、Lm、W自由组合
墨桶配置	2.5升桶连续供墨系统,带白墨循环系统
软件配置	Photoprint12 UV专用版本
色彩控制	国际标准的ICC颜色控制,曲线和密度用户可调等功能

设备型号	SGV3200-V05
文件格式	TIFF, FPEG, Postscript3, EPS, PDF等
打印规格	最大打印宽度3200mm 打印介质厚度: 0.18-8mm
数据接口	高速USB传输
固化系统	双水冷LED UV灯,双快门控制系统,快门可通过软件单独控制,适用于各种不同需求
接入参数	AC220V(±10%) 单相, 35A、50/60Hz; 5KW
机器规格	机器尺寸: 5540*1000*1685mm;重量: 2300Kg
包装箱尺寸	长、宽、高: 5720mmX1100mmX1920mm
环境要求	独立、洁净、低尘、少光照、通风良好的工作间;环境温度: 18-30℃;相对湿度: 30%-70%;(无冷凝)通风设备;建议使用架空排气扇,排气量600cfm